



Light quality control



GL GONIO SYSTEMS

Photometry redefined

Modern lighting quality standards require full characterization of LED modules, lamps and luminaires, including photometric and colorimetric measurements along with temperature and electrical power measurements. GL Optic supports lighting companies and testing laboratories with high performance instrumentation for a complete light quality control.

GL GONIO SYSTEMS



Table of contents:

- 4** First get to know us better
- 6** Choosing the best goniometer system for your needs
- 10** 6 things making GL Gonio a unique solution
- 12** **GL SPECTROSOFT**
The brains behind our systems
- 14** **GL System**
Optimized for each application
- 16** **GLG 30-1800 Large system**
- 20** **GLG 4-500 Light Goniometer Table top**
- 24** Quality, Price & Support
- 26** Technical data



Light quality control

First get to know us better.

At GL we believe that the true quality innovation is about the best technology and not about gadget functionality. This is why we encourage all potential customers to choose quality instruments for their lighting product quality control.

There are many light meters available on the market today but we know what matters most for fast developing lighting manufacturers: engineering, precision, performance and, equally important, independence from external quality testing labs. For many manufacturers the possibility of optimizing product quality and faster prototyping are advantage factors helping them to win the market share.

Unlike mass produced devices, GL instruments are individually calibrated for the end user allowing for accurate and dependable results and helping to make the right product quality decisions.

Our instruments feature automatic dark current compensation combined with a temperature monitoring system which allows everyone to use the system whenever and wherever they need dependable data.

The unique plug-and-measure concept by GL features the RFID codes helping to automatically get the calibration files for each available accessory and allowing quick, easy and precise measurements of different lighting quantities. Changing from lux to lumen and even luminance values is as easy as changing the available accessories. Leave it to the system to take care of the rest.

“The ultimate light quality control systems available only for best lighting quality product manufacturers”

GL OPTIC IS A FULL-LINE MANUFACTURER OF COMPLETE INSTRUMENTATION FOR PROFESSIONAL SPECTRAL LIGHT MEASUREMENT

At GL we design, manufacture and support light quality control systems that help modern lighting companies develop their products faster and better by using the knowledge, technology and expertise which is built in every light measurement instrument we provide. With the use of our instruments and software lighting companies get control over quality from the moment of components purchase through the research and development stage up to the final product testing.



Origins

GL Optic was established in 2009 to develop and bring innovative solutions in light measurement. Since its establishment GL Optic has been growing, developing products, setting industry standards and expanding sales all over the world.

Nowadays GL Optic is at the stage of developing R&D centre and expanding its services. The company is finalizing the construction of a new photometric laboratory equipped with Poland's first black body (BB) model, the first primary standard radiation source in Central Europe.

Our Leadership Team



Michael Gall

CEO of Just Normlicht

co-founder of GL Optic and an open-minded entrepreneur with many years of experience in lighting technology for visual colour assessment.



Miko Przybyla

COO of GL Optic

a partner, light quality enthusiast and head of GL business development and operations.

Light quality blog



Jan Lalek

CTO of GL Optic

co-founder of GL Optic – physicist and optical engineering expert, passionate about colorimetry, optics and modern technology.

Choosing the best goniometer system for your needs



HOW TO ORGANIZE A MODERN PHOTOMETRIC LABORATORY?

(first published by Miko Przybyła in LED Lighting Magazine)

Selection of the goniometric system

Many manufacturers of lighting products use external measurement laboratories to verify compliance with standards and assess performance. Some manufacturers or importers rely solely on their suppliers' datasheets and try to avoid having to carry out measurements on their own. This situation is quite common not only among small start-ups but also larger lighting companies in many European countries and beyond.

This situation is due to the low awareness of how much the parameters of the components differ from the functional parameters of the finished lighting product. Apart from that, paradoxically, many times higher capital expenditures are made on the organization and equipment of production departments, and it is difficult to find appropriate funds to finance the implementation of quality control while at the same time manufacturers find it impossible to verify what is actually delivered to customers.

Why it is worthwhile to have an in-house laboratory?

This trend has recently changed and the need for in-house verification of product quality and laboratory or in-house quality control within the company is increasing. This is due to the increasing competition in the market and the need to optimize products and look for unique technological solutions. Moreover, with the multitude of different products in the manufacturer's catalogue, sending luminaires and components for testing to an external laboratory becomes time-consuming and even too expensive. Regardless of the size of the company and its business profile, more and more companies decide to build their own photometric laboratory in order to verify the quality of their products, compare them with the competition and better select quality components purchased from different suppliers. This approach has many advantages: it supports the sustainable development of the company and strengthens its market position. Companies with their own measurement facilities make fewer mistakes at the design and product introduction stage, can better select components and suppliers. In addition, companies are able to react more quickly to changing technology, the know-how remains within the company and a lasting advantage over the competition is built, and the company's value increases.

Let us begin the discussion on the organization of an in-house photometric measurement laboratory with the proper selection of an appropriate goniometric system. What types of goniometers are available and which ones should be used in the measurement of lamps and luminaires for general lighting purposes, and which ones in the measurement of technical lamps and illuminators? What are the ways of measurement and what values can be measured? In addition, we will analyze the measuring equipment necessary specifically for the characterization of LED products. We will also describe the requirements and suggestions for the preparation of the laboratory room.

Types of goniometers used in photometry

Different types of goniometers are available on the market; they are distinguished by their geometry of measurement, i.e. how photometric data are collected and how the measuring system is implemented in a mechanical sense.

Types of goniometers can be basically divided into groups 1, 2 and 3, described in detail in CIE 70 of 1987.^[1] These types are also called A, B and C

¹ CIE 70-1987 The measurement of absolute luminous intensity distribution.

and differ in the way the luminaire is rotated during measurement and in the system of photometric data obtained during such measurements.

Schematic drawings and a description of the different types are shown in Figure 1.

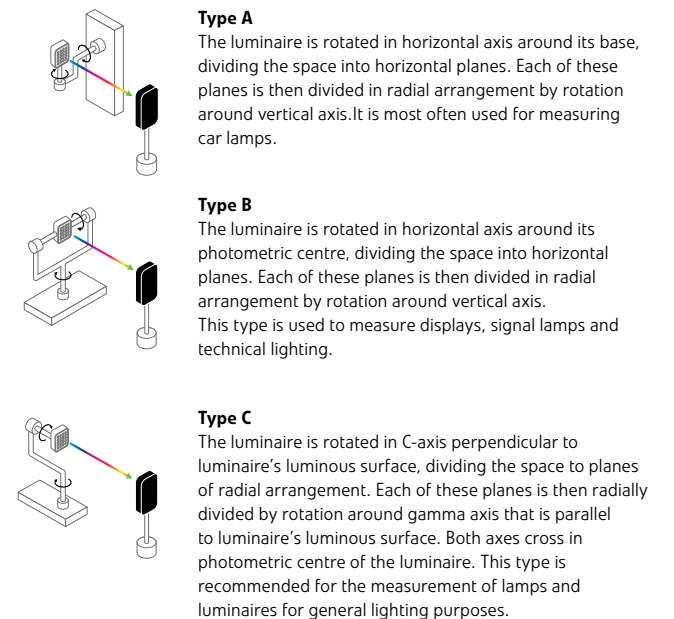

Fig. 1. Types of goniometers

For photometric measurements of products intended for general lighting purposes it is recommended to use a type C goniometer. Goniometers A or B, on the other hand, are most often used in the measurement of car lamps, projectors and signal lamps in land transport and aviation.

It is worth mentioning that there are also different designs of C-type goniometers. When measuring gas discharge lamps, the position during measurements must be identical to the working position of the luminaire, because the change in the position of the light source significantly changes the level of the light output – lumen (total luminous flux). For this purpose, goniometers with movable measuring arm or goniometers with mirror modes are used. Both of these solutions are very expensive and require very large laboratory rooms in order to ensure a suitable minimum distance for photometry - which will be discussed further below. When measuring LED lamps and luminaires, goniometers rotating the luminaire are most frequently used, and the measuring device is located at

a fixed, sufficiently distant point. The operating position of a light-emitting diode does not fundamentally affect its performance and efficacy. There are only differences due to the different heat dissipation by the radiator, which can result in a decrease in light output. However, the differences in the readings of the luminaire's flux values depending on the position of the luminaire are usually just over 1 to 3% and can be compensated by using an appropriate measurement procedure and corrections made to the measurement results in accordance with the recommendations of international recognized standard CIE S025 E:2015.

Far-field goniometers versus near field goniometers

All goniometers are used primarily to collect photometric data, i.e. the so-called LID diagrams (luminous intensity distribution) that represent the spatial distribution of light [cd] of the source. These data characterize a luminaire or a source and are necessary for the purpose of lighting projection with the use of light design software.

The straight forward way to calculate the value of light intensity [cd] is using the lux values and distance, therefore most often far-field goniometers are used. Such a measuring system assumes the placement of a measuring device distant from the source at such a distance at which the shape and dimensions of the luminaire are not important and it is measured as a point source. The appropriate distance is the so-called minimum photometric distance, i.e. the distance for which the inverse of the square law is true. When determining the minimum photometric distance, it is advisable to follow the recommendations of CIE standards, which suggest a distance of 5, 10 or 15 times the size of the luminaire's illuminating surface. Thus, with a luminaire size of 1 m, the minimum distance should be 5 m for luminaires with wide distribution and soft LID shape. For luminaires with narrow distribution, measurements from a distance of 10 m are suggested, and for specific luminaires with directional distribution measurements from a distance of 15 m are suggested (Fig. 2).



Fig. 2. The photometering distance depends on the size of the luminaire.

For luminous intensity calculations based on luminance [cd/m^2] of the luminaire near-field goniometers are used, which most often employ imaging luminance meters located at a short distance from the tested source; they measure the luminance of the illuminating surface at different angles. Such a solution is currently not recommended for the measurement of absolute photometric values in luminaires and is most often used in the case of testing displays or technical illuminators.

Modern implementations of goniometric systems will use fully programmable, computer-controlled mechanical-electronic systems. The use of servo motors with absolute encoders in the drive enables precise control and reconstruction of the goniometer position. In addition to the control of both the C and gamma axes, systems with motorised Z axes are also available, allowing for convenient positioning of different luminaires of

different sizes in the measuring axis. Advanced swivel connectors allow the power supply and measuring circuits to be supplied directly near the mounting plate without the risk of entanglement of the power supply cables when the luminaire is rotated. The figures below show a type C-type goniometer with three mechanized axes and a schematic diagram of how to create goniometric files for a typical luminaire (Fig. 3).



Fig. 3. Type C goniometer with three mechanized axes and schematic diagram of creating goniometric files for a typical luminaire.

Preparation of the room

As it is easy to notice, the size of the tested luminaire with far-field goniometers recommended for measurements of luminaires has a significant impact on the size and location of the laboratory room. When deciding on the location, the minimum working area of the goniometer, the length of the room and the space for the operator should be taken into account. A working area of 2.5 x 2.5 m should be provided for a typical 1.5 m or 1.8 m long goniometer for luminaires. The length of the room, depending on the size of the tested luminaires, should be from 7 to 10 m, and in some cases even 15 m. When planning the location of a room, it can be predicted that the distance between the luminaire and the device on a tripod will usually be 10 m. When measuring larger luminaires, which are rarely measured, if possible, we move the tripod with the measuring device to an adjacent room or set it up in a corridor. Such solutions work well in many large companies and even accredited laboratories all over the world.

Of course, according to the recommendations of the standards, the measuring room should be dark, without access to daylight (during measurements) - walls, ceiling and floor covered with material or paint with a low reflection index (black or graphite). The room should be free of dust, vibrations and a stable temperature of 25°C and air movement should not exceed 0.25 m/s. Professional goniometric systems are equipped with a measuring head with a tube limiting the so-called stray light, i.e. unwanted light reflected from elements and surfaces of the laboratory, which could be measured by the measuring system. Thanks to this solution, no additional partitions (baffles) between the luminaire and the measuring device are required. The tube is equipped with specially designed elements limiting the influence of diffuse light and limiting the viewing angle of the measuring head. In practice, this means that it is possible to work in the darkroom at the operator's workstation with illuminated workstation and the blackening can be limited to the work area of the goniometer and the surface directly behind the goniometer.

When choosing a goniometric system supplier, it is worth paying attention to the technical support that can be provided by the manufacturer.

Many important decisions should be made well before the purchase of measuring equipment. Moreover, at the installation and training stage, many questions arise, especially from people who will be trained in the operation of the system. It often happens that they do not have any experience in photometric measurements. During the use of the equipment, there may also be many new questions or issues to be solved, and it is worth having the opportunity to receive appropriate support and possibly training from the manufacturer.

Special requirements for LED measurement

LED measurement is not only related to photometric values such as light distribution curves [cd] or the calculation of the total luminous flux [lm]. For the full characteristics of LED products it is necessary to ensure appropriate power supply conditions and measurements of electrical quantities. Therefore, with such a comprehensive approach to measurements in a complete measurement system, it is worth taking into account programmable and stabilized laboratory power supplies. In addition, the requirements for ambient temperature measurement can be implemented by including sensors for temperature recording in the system. All this can be controlled by a single software interface to control optical, electrical and temperature measurements. This makes it easier to ensure appropriate working conditions and to prepare comprehensive measurement reports in accordance with the latest guidelines of international standards.

Unlike traditional goniophotometers, modern goniometric systems use spectroradiometers, which can be calibrated to measure absolute photometric values and to measure colorimetric values simultaneously. Due to their specific construction, LED lamps and luminaires should be measured using a spectroradiometer, which can provide appropriate, accurate measurement data for chromatic coordinates x, y, Duv index, correlated colour temperature, colour rendering indexes Ra and CRI. In addition, LED products can have different colour temperature depending on the angle of illumination, and the use of the spectroradiometer in combination with the goniometer, i.e. goniospectroradiometer, allows determining the angular uniformity of colour according to the recommendations of the CIE standards incorporated into European standards EN 13032-4:2015-09 and IES LM 79.

Electrical measurements

The choice of power supplies and electric meters should be dictated by the type of products to be measured. End products, ready-to-use LED luminaires or LED lamps for retrofitting require testing in conditions similar to those in which they will operate in a ready-to-use lighting installation. This usually means working with alternating current with different voltage and frequency ranges. For this reason, it is important to be able to simulate different operating environments with a single power supply.

At the LED product development stage, manufacturers are forced to test individual components individually to check their impact on the finished product. In this situation, testing will require the use of DC power supply, less often alternating voltage.

Laboratory DC power supplies are able to provide the exact current required using automatic voltage regulation, which in the final operating environment of the finished product will depend on many factors that are difficult to control.

As with standard electrical measurements, the influence of the entire electrical circuit must be taken into account. Each power cord of the test sample has its own resistance and causes a voltage drop. It is worth taking care of cable distribution, not only taking into account the safety and comfort of operation, but also the voltage drop. This requirement increases

with higher current values, which can be reduced by using thicker and shorter wires with lower resistance.

The most professional approach to the problem described above consists in doubling the measurement functionality by using - apart from power supplies - also a dedicated power meter. A suitable meter can work with alternating and direct current over a wide range of voltages and frequencies with accuracy even greater than in the case of power supplies. In addition, such meters include a wider range of electrical parameters that allow you to meet the requirements of separate electrical tests. The biggest advantage of the additional use of a separate power meter is that it can measure the voltage directly at the sample, thus eliminating the impact of voltage drop on the entire supply circuit. This is where the design of modern goniometers can be used to provide additional supply and measurement circuits near the mounting plate on the goniometer column.

Additional functions

With a large number of luminaires, time is the most common problem in photometric laboratories. New designs of goniometers may allow for so-called on-fly measurements, i.e. without stopping the goniometer after setting the arm at a particular angle. In this variant, the luminaire is rotated in a given position (plane) in a uniform manner, and the fast measuring system collects a large number of measurements from the whole range. Thanks to the readings from the encoder, the computer program assigns the measured value to the preset grid of measurement steps. This requires a very fast measuring system.

For optimal use of laboratory space and ease of use, it is advisable to consider installing additional slides (rails) for smooth adjustment of the tripod with the measuring head along the measurement axis. For the measurement of small objects with a small flux, the measuring distance can be reduced without the need to set the measuring axis.

It is worth remembering that different formats of photometric files are used on the European market and beyond. Currently, the most popular are EULUMDAT (European format), IES (American format) and IEC format files used in some industries and in various regions of the world. For this reason, the software supporting measurements, reports and file formatting should be universal. It should also be possible to freely import and export photometric data and combine measurement files and photometric curves from different measurements.

Calibration of the entire goniometric system is not necessary and is not practiced. If a spectroradiometer or photometer is used, the measuring device itself must be calibrated. The manufacturer should provide a factory calibration certificate or, if requested by the customer, a calibration certificate from an accredited laboratory.

Summary

Let us remember that the choice of the right equipment is very important, but this is only the beginning. It is worthwhile to start planning the organization of the in-house laboratory in good time and take into account additional organizational and logistical aspects.

We should also remember to prepare and train our staff – to that end it will certainly be helpful to choose a supplier who will not only sell the measuring equipment, but who will also be able to provide appropriate support at all stages of the process.

ACCESSIBLE, EASY-TO-USE AND RELIABLE

Competitive lighting market demands faster prototyping, better optimization and improved time-to-market.

If your company is introducing many lighting products and wants to stay ahead of competition offering best technology solutions, then GL Gonio Systems are the best choice for your lighting products quality control. These premium instruments provide the best lighting companies with photometric data about their own products.

Invest in premium photometry instrumentation and start using the quality of your products to win market share and build your competitive advantage.

Luminous Intensity Distribution (LID)

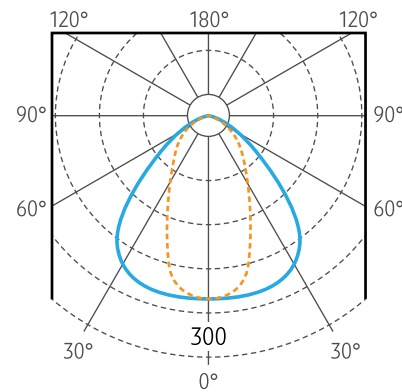

Spectral Power Distribution (SPD)

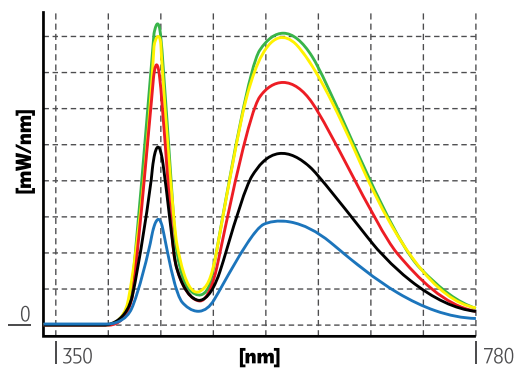

TIME FOR A GONIO SPECTROMETER

LED and other modern lighting systems require both photometric and colorimetric evaluation. GL Optic was one of the first system providers to combine a gonio set with a spectroradiometer for full characterization. When you have many lamps and luminaries to test, it becomes expensive and time-consuming to continue sending lamps to an external laboratory. Now not only can you control this process yourself, but you can save time and money while also build up important knowledge inside the company.

6 things making GL Gonio a unique solution



- 1 User friendly interface helping you to get the data in no time
- 2 Mechanical stability and size to handle multiple lighting products
- 3 Quality gears and absolute encoders for superior repeatability
- 4 Laser alignment tool and manual controller simplifying the process
- 5 Cable management and rotation connectors for instant power supply
- 6 Accessible

The brains behind our systems

Usually little is mentioned about the software when competitive gonio systems are described.

At GL we believe that it is of key importance to first check and then to buy. Make sure how you get the control of the instrumentation during your measurements.

Don't forget that it is the user friendly interface that will make your life easier and help you appreciate the high quality of the instruments.

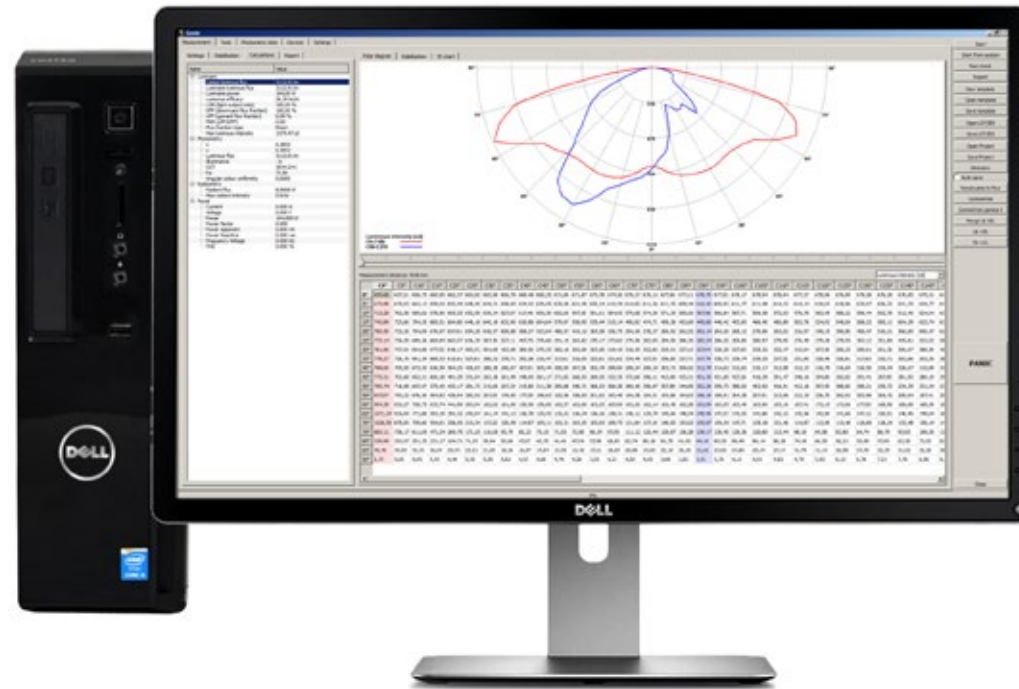

SPECTRORADIOMETRIC DATA

The default system uses a calibrated spectroradiometer for full photometric and colorimetric characterization of DUT*. Spectral data are stored in the software and the LID** data are put on the table. Additionally a Total Luminous Flux calculation is made at the end of the measurement process. UV and IR optical radiation distribution measurements are available with GL SPECTIS 5.0 touch.

MECHATRONICS CONTROL

The software is automatically controlling mechanical gears offering free selection of the number of steps and angles available for both C and Gamma axes +/- 180 deg. Choose from existing templates or create an individual measurement grids for your lamps.

ABSOLUTE ENCODERS

Each motor is equipped with absolute position encoders which communicate with our software to improve angle accuracy and alignment. Relative positioning available in entry level systems with step motors is not sufficient for a laboratory repeatability of the system.

AUTOMATIC BACK-UP

During the entire measurement process the software saves data files automatically. Back-up files allow for repetitions so measurements can be continued from an individually selected point to a complete measurement procedure.

Very helpful tool to avoid data loss due to electrical shutdown!

NEW FAST PHOTOMETER + FLICKER

This new optional instrument can be used for fast on-fly measurements combined with optical flicker characterization of DUT*. The software includes all the latest flicker metrics according to EU and US standards.

POWER SUPPLIES

A programmable and stabilized power supply can be controlled using single user interface simplifying measurement procedure and saving time.

POWER MEASUREMENTS

Extended measurement of electrical power is available with the use of additional connections to include full electrical testing in the measurement report compliant with Energy Star and Eco Label Design requirements. This can include optional harmonics and high resolution electrical measurement data.

TEMPERATURE CONSIDERATIONS

Temperature measurements close to DUT* are available with a USB controlled measurement unit or optional TEC stabilized mounts for LED modules paired with programmable controllers.

EASY TO NAVIGATE

ADVANCED TOOLS

FLEXIBLE AND CUSTOMIZABLE REPORTS

LIFETIME LICENCE POLICY

ONLINE SUPPORT

MULTIPLE LANGUAGES

DIFFERENT SOFTWARE LICENCE LEVELS

COMPLIANCE & UPDATES

Intuitive, clear and easy

One software interface to program, monitor and manage a complete measurement system. Starting from power supply through the stabilization process up to the final results and reporting.

Our software is built for the operator and it will take short time to get the measurement process done if all you want is photometric files. With flexible import and export functions you can get the files in any available format IES, LDT, IEC ...

If you are looking for more advanced product testing and measurements in accordance with international lighting standards you will find everything you need for a professional laboratory work. Unlimited data capture options and peripheral devices integration are available.

Our RTF reporting system allows the user to create custom report templates and save them as defaults for future use. Simply open the document in any editor and prepare the layout of your company's reports by including your company logo, fonts and colours in line with your company identification system. You can even upload photos of your lighting products and include selected measurement data.

All GL customers are provided with a lifetime software license and can be sure to get continuous access to the latest software versions available for download online. Simply download the latest version of the software from the link and enjoy using our tools.

We offer continuous online support for end users worldwide. 95% of support calls can be resolved quickly by remote support sessions provided by our highly educated and experienced support engineers. If you need technical assistance, please complete the form available on gloptic.com/support and we will get back to you as soon as possible.

Being a European manufacturer, GL Optic offers GL SPECTROSOFT in many languages, e.g. English, German, French, Italian, Polish, Russian, Chinese, and more. Please contact us to make sure your native language is available.

GL SPECTROSOFT is available in different software license levels to meet the demand of the end user. Starting with entry level BASIC configuration through the professional software license up to the laboratory license level. You can also pick and choose from the available Add-Ons and tools. Please see the table for details.

We are always up-to-date with the latest international, European and American lighting industry standards and market requirements. We follow up CIE, IEC and IES standardization committees to include the latest metrics in our software. We are also open to suggestions from our end users to make our software a useful analytical tool for specific applications.

*DUT – Device Under Test
**LID – Luminous Intensity Distribution

GL SYSTEM

Optimized for each application

Multiple configurations are available for different measurements and applications. Take a look at available instruments and peripheral devices and contact us to confirm the details of your configuration with GL team.

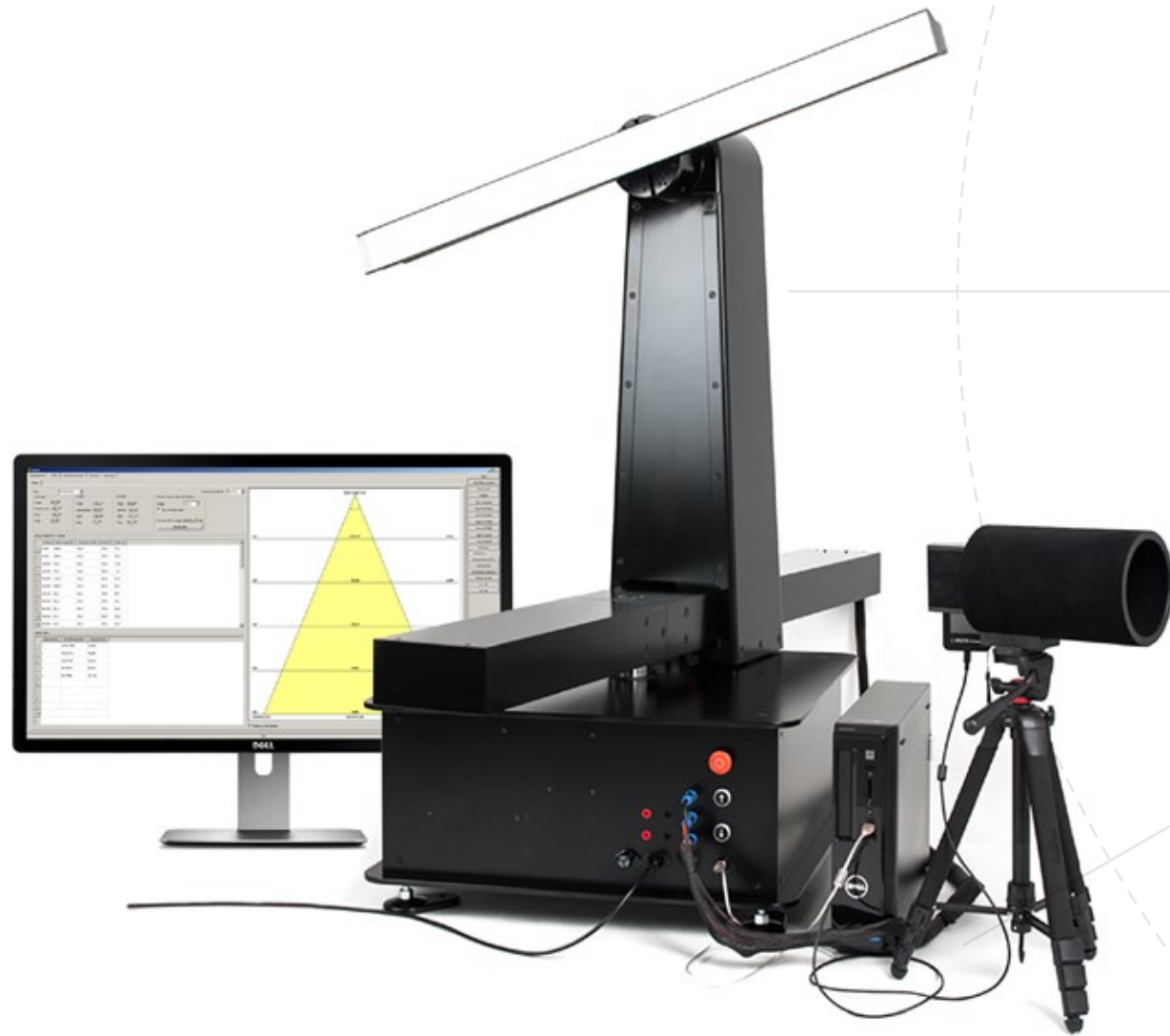

PERIPHERALS

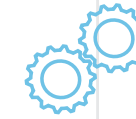

AUTOMATION



SPECTIS 5.0

Check angular distribution of optical radiation in an extended spectral range from UV to NIR in a variety of applications.

SYSTEM CORE

GONIOMETER

Programmable robust and accurate Type C goniometer with 3 mechanized axes.

SOFTWARE + PC

GL offers preconfigured, turn-key system including all instruments with software and a dedicated PC which is tested prior to shipment to customer.

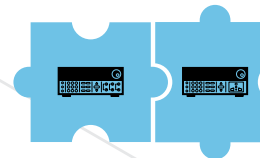
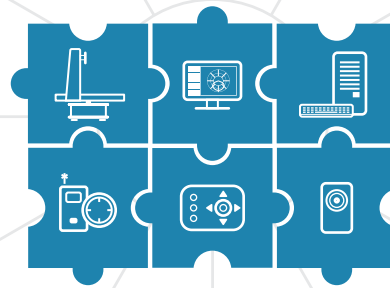

POWER SUPPLIES & METERS

Choose from available power supplies and current sources for a full electrical characterization of DUT*. Advanced power meters and fast current sources from leading suppliers available on demand.

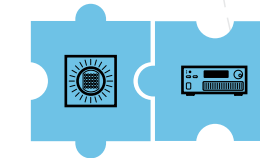

TEC CONTROL

TEC controllers and mounts for LED modules thermal stabilization and measurements during goniometric tests are available.

ACCESSORIES

Unique laser alignment system with mirrors and system control options helps to calibrate system vertical and horizontal alignment and also faster photometric positioning of DUT*.

SPECTIS 1.3 LS

High sensitivity version of our popular spectroradiometer optimized for fast photometric & colorimetric measurements.



FAST PHOTOMETER + FLICKER

On-fly measurements available with this new optional instrument combined with optical flicker characterization of DUT*.



Support & Installation

Online and On-site extensive know-how support for end-users to help them manage their complex measurements.

*DUT – Device Under Test



GLG 30-1800

Large system

This goniometer, which delivers fast and reliable results, can be used in factory laboratories as well as in accredited laboratories. With easy to use software, precise alignment protocols and extensive automation capabilities, the system offers a new level of performance and usability.

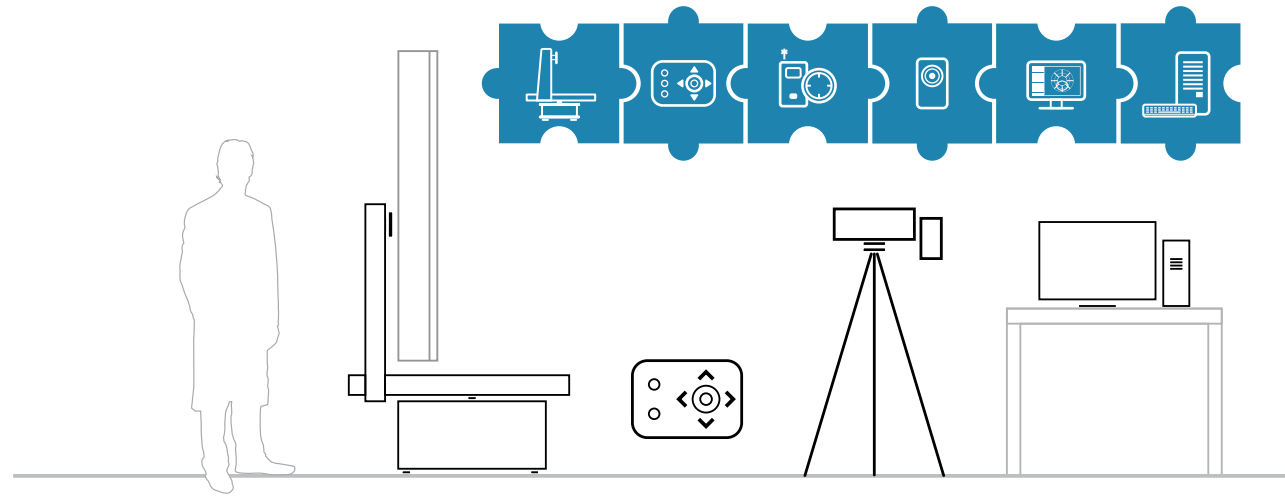

6 things making GL Gonio a unique solution

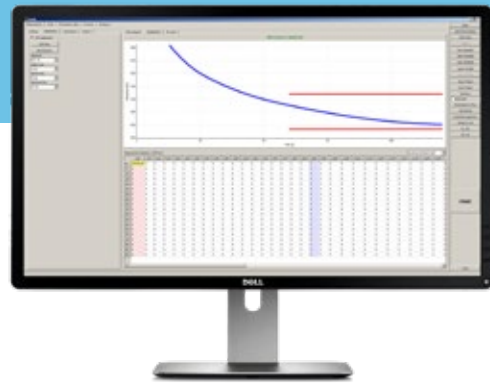

CIE S:025 Compliant Stabilization INCLUDED!



ONE CLICK Photometric File Output

While this goniospectrophotometer generates spectral and colour data at any angle, it remains true to its primary use – generating IEC/LDT output files simply and with the click of a button.



A Wide Range of Luminaires

With an extended max load of up to 30 kg and 1800 mm max diameter, the GLG 30-1800 will cover most of testing demands.

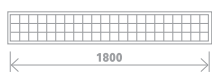

Have a range of small and large fixtures?

No problem. The system can accurately characterize large and small fixtures without any mechanical changes.

1 Manual controller supports the user to align the lamp position before measurements. An easy to use software interface shortens configuration time and allows for quick DUT description and settings.



2 Robust CNC machined body of the device is durable and stable enough to hold large lamps and guarantees long lasting performance. Exceptional lamp size capacity 1800 mm x 700 mm.



3 Tried and tested industrial gears paired with high accuracy absolute encoders to provide best angular accuracy and repeatability.

4 Unique laser alignment system with mirrors and system control options helps to calibrate system vertical and horizontal alignment and also faster photometric positioning of DUT.



5 Smart cable management system will help keep the cables neat and turning connectors to avoid problems with tangled cables during tests and faster connections.
• Banana connections right next to the DUT provide the necessary electric power stability.



6 Reasonably priced high performance professional instrumentation now available for quality lighting product manufacturers.



Large System GLG 30-1800

3 LEVELS OF CONFIGURATION AVAILABLE, DEPENDING ON THE BUDGET AND REQUIREMENTS

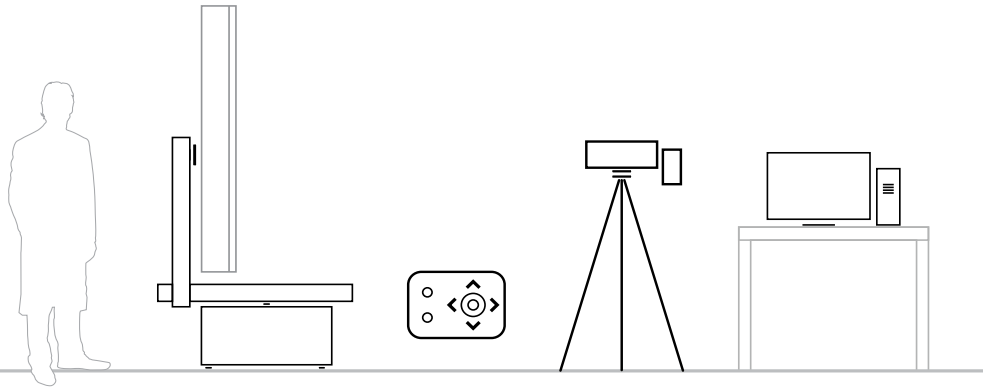
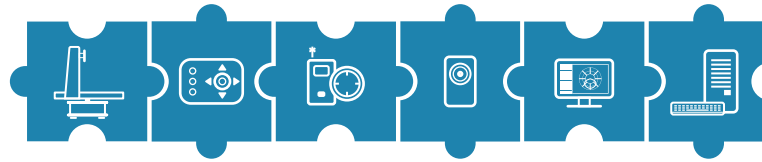

BASIC

Entry level configuration for simple access to photometric data providing minimum functionality mainly to generate photometric files. This will include the gonio with simple tripod and Stray Light Hood together with measuring device GL Spectis 1.3 LS recommended for photometric + colorimetric tests.

GL GONIOMETER

GL GONIO SPECTROMETER GLG 30-1800
 + Laser Alignment Tool
 + Mirrors
 + Bosch distance meter
 + GL tripod
 + Stray Light Hood

GL SOFTWARE

GL Spectrosoft PRO

GL SPECTROMETER

GL SPECTIS 1.3 LS

ACCESSORIES

Windows desktop PC for GL Optic System

PROFESSIONAL

Optimal setup for advanced photometric and colorimetric analysis and reporting. In this configuration we add some improved functionalities such as:

- Professional tripod and stray light tube which will not only provide reflection rejection but is designed to increase the light level in the measurement device to allow for speedier tests
- Manual controller (joystick) to significantly simplify accurate alignment of DUT before start
- Railing system is available for professional tripod if changing of photometric distance is necessary
- On-fly measuring is available with the use of optional fast photometer for speedier tests

GL GONIOMETER

GL GONIO SPECTROMETER GLG 30-1800
 + Laser Alignment Tool
 + Mirrors
 + Bosch distance meter
 + GL tripod
 + Stray Light Tube

GL SOFTWARE

GL Spectrosoft PRO

GL SPECTROMETER

GL SPECTIS 1.3 LS

ACCESSORIES

Windows desktop PC for GL Optic System

GL rails for tripod

GL stray light tube for spectrometer

GL gonio manual controller

LABORATORY

Accredited lab level set for most demanding jobs using scientific detectors for advanced tests and measurements and for accredited laboratory environments. GLG system is available in the top end configuration.

This setup uses laboratory level measuring instrument GL SPECTIS 5.0 Touch which not only offers the highest optical resolution in the extended spectral range but also provides increased sensitivity which will support demanding optical measurements of technical lighting or scientific research beyond the visible spectrum

GL GONIOMETER

GL GONIO SPECTROMETER GLG 30-1800
 + Laser Alignment Tool
 + Mirrors
 + Bosch distance meter
 + GL tripod
 + Stray Light Tube

GL SOFTWARE

GL Spectrosoft LAB

GL SPECTROMETER

GL SPECTIS 5.0 Touch VIS

ACCESSORIES

Windows desktop PC for GL Optic System

GL rails for tripod

GL stray light tube for spectrometer

GL gonio manual controller

GL Opti Probe 5.1.50

Large GLG30-1800

OPTIONAL AND PERIPHERAL DEVICES



GL SPECTIS 5.0 Touch UV VIS NIR

Check angular distribution of optical radiation in an extended spectral range from UV to NIR in a variety of applications.

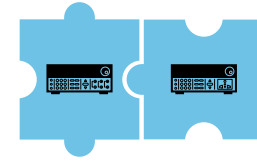

Power supply

Choose from available AC & DC power supplies and current sources for a full electrical characterization of DUT. Advanced power meters and fast current sources from leading suppliers available on demand.

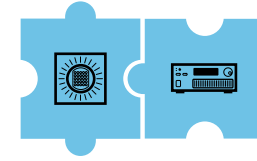

TEC mounts and controllers

for stabilization of LED modules temperature during test and measurements



Fast photometer

GL PHOTOMETER 3.0 LS + Flicker

for On-Fly intensity distribution measurements combined with flicker parameters testing



Professional tripod and rail system

available for quick photometric distance adjustments



AUTOMATION

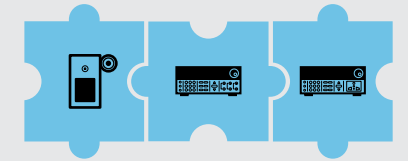

GL SPECTIS 5.0 Touch UV VIS NIR + POWER SUPPLIES

Expand the Gonio usability by adding GL AUTOMATION

The world of LED light measurement is expanding beyond traditional optical testing with thermal conditions, current or power levels also requiring measurement and reporting.

GL Spectrosoft Automation is an optional Add-on for Spectrosoft and it was purpose built to control these complex testing procedures. Once you connect all devices which are supported by the AUTOMATION software, building a custom measurement script is simply a matter of using the drag and drop interface and selecting the logical sequence from the list of available commands to the Automation editor window.

Thanks to AUTOMATION the integration of programmable power supplies, power meters, temperature meters and even TEC controllers for thermal stabilization with the gonio systems has become easier than ever before.



GLG 4-500 LIGHT GONIOMETER

Table top

A table top system for Light Intensity Distribution, Luminous Flux and Colour measurement.

This easy-to-operate system combines the functionality of a goniophotometer with the features of a spectroradiometer to measure flux and to check angle dependent luminous intensity together with the colorimetric data required by international standards. The upgraded GLG 4-500 version is a table top light goniometer specifically designed for LED modules and component testing. This setup can also be used for smaller luminaires measurements. The automated, PC based system can hold devices of up to 4-7 kg and 500mm in diameter and measures with an angular resolution of 0.1° and C-plane and γ angle +/- 180°.

Comprehensive instrumentation for speedier product testing

for luminous intensity and optical radiation distribution measurement in general lighting, technical and scientific application areas.

Unique, flexible and upgradable systems to simplify product compliance

Unlike many competitive systems GL gonios can be modified to meet client requirements.

LED modules test & measurements

When working with LED modules or COBs you may need to stabilize the junction temperature. This is required for specific performance tests to verify flux output and intensity distribution under different temperatures. This option is also used for optical components testing used in lamp production like lenses, diffusers and reflectors.

Optical radiation intensity distribution measurements

When working with UV or IR LEDs an optical distribution pattern is needed to verify the spatial performance of products. Such measurements are possible with the use of our laboratory grade spectroradiometer GL SPECTIS 5.0 Touch UV – VIS – NIR. This instrument will cover expanded spectral range measurements with high optical resolution.

Optical sensors angular sensitivity tests

Manufacturers of optical sensors in vision systems, industrial automation and consumer appliances are looking for ways to check how the sensitivity of optical sensors is changing with the angle or distance. GL gonio systems can be used for such measurements and can create an Angular Sensor Sensitivity Pattern (ASSP). This can be available not only for visual range sensors (light sensors) but also in specific IR ranges used in remote controls, proximity sensors, object detection systems and other.

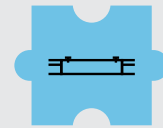
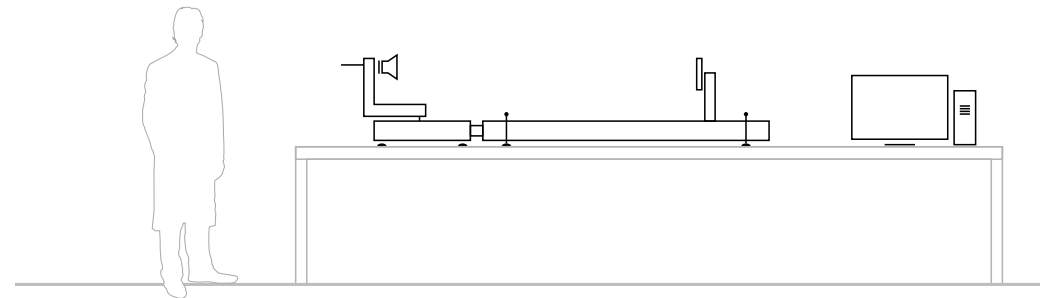
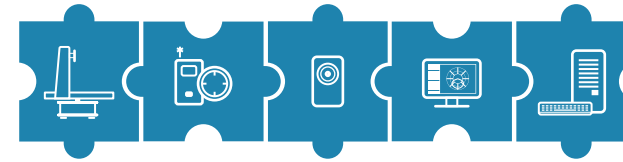

Sliders + extensions
Optional sliders including integrated mount for the measuring device are available. This helps to quickly adjust photometric distance.

Sliders of 1 m or 2.5 m long are available on demand. Additional extension profiles can be ordered to meet different laboratory room requirements.

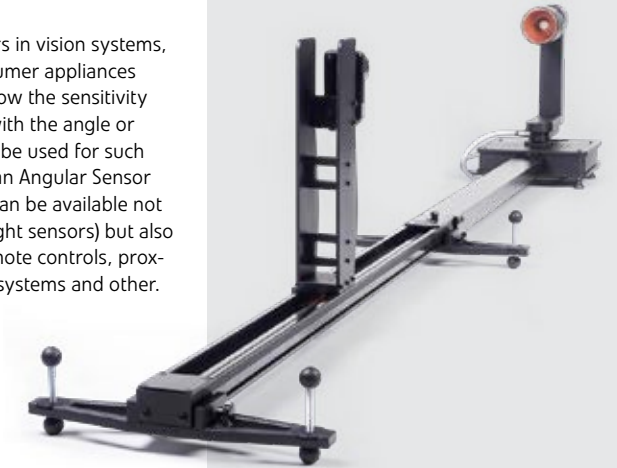
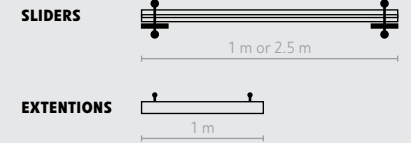

6 things making GL Gonio a unique solution

1 Simple interface to perform advanced tests and measurements.

2 Build-to-last mechanical system with integrated aluminium base including controllers and connectors with plug-and-measure concept. Ideal for LED modules and linear lights.

3 Programmable turnkey system with smooth and quick operation. Optional sliders for optimum photometric distance settings are available.

4 Included laser alignment tool allows for quick positioning and distance measurements.

5 Connectors for peripheral power supply in the base are wired with banana sockets placed close to DUT

6 Best price quality ratio on market and easy operation



Table Top
GLG 4-500 Light Goniometer
3 LEVELS OF CONFIGURATIONS AVAILABLE, DEPENDING ON THE BUDGET AND REQUIREMENTS

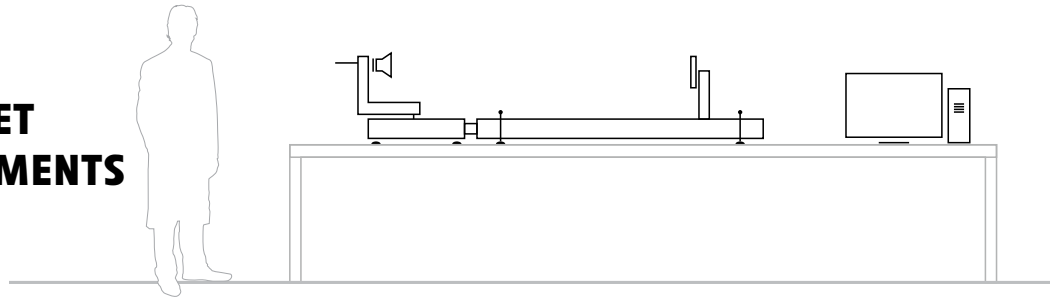
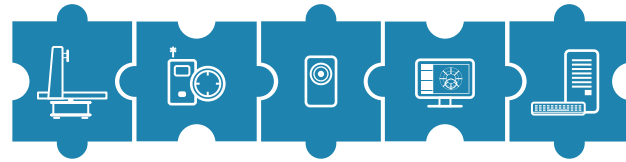

BASIC

Entry level configuration for simple access to photometric data

GL GONIOMETER
GL GONIO SPECTROMETER GLG 4-500 + Laser Alignment Tool + Mirrors + Bosch distance meter
GL SOFTWARE
GL Spectrosoft PRO
GL SPECTROMETER
GL SPECTIS 1.3 LS
ACCESSORIES
Windows desktop PC for GL Optic System
GL tripod
Stray Light Hood

PROFESSIONAL

Optimal setup for advanced photometric and colorimetric analysis and reporting

GL GONIOMETER
GL GONIO SPECTROMETER GLG 4-500 + Laser Alignment Tool + Mirrors + Bosch distance meter
GL SOFTWARE
GL Spectrosoft PRO
GL SPECTROMETER
GL SPECTIS 1.3 LS
ACCESSORIES
Windows desktop PC for GL Optic System
GLG Slider 2500
GLG Slider extension 1000
Stray Light Tube

LABORATORY

Accredited lab level set for most demanding jobs using scientific grade detectors

GL GONIOMETER
GL GONIO SPECTROMETER GLG 4-500 + Laser Alignment Tool + Mirrors + Bosch distance meter
GL SOFTWARE
GL Spectrosoft LAB
GL SPECTROMETER
GL SPECTIS 5.0 Touch VIS
ACCESSORIES
Windows desktop PC for GL Optic System
GLG Slider 2500
GLG Slider extension 1000
Stray Light Tube
GL Opti Probe 5.1.50

Table Top
GLG 4-500 Light Goniometer
OPTIONAL AND PERIPHERAL DEVICES

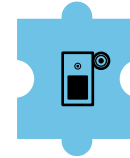

GL SPECTIS 5.0 Touch UV VIS NIR

Check angular distribution of optical radiation in an extended spectral range from UV to NIR in a variety of applications.

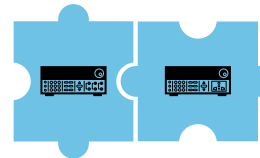

Power supply

Choose from available AC & DC power supplies and current sources for a full electrical characterization of DUT. Advanced power meters and fast current sources from leading suppliers available on demand.

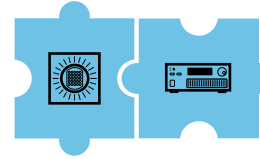

TEC mounts and controllers

for stabilization of LED modules temperature during test and measurements



Fast photometer

GL PHOTOMETER 3.0 LS + Flicker for On-Fly intensity distribution measurements combined with flicker parameters testing

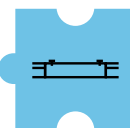

Sliders + extensions

Extension profiles can be ordered to meet different laboratory room requirements.



AUTOMATION

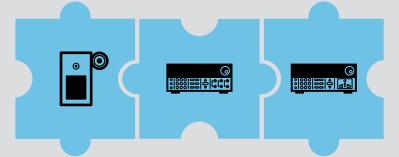

GL SPECTIS 5.0 Touch UV VIS NIR + POWER SUPPLIES

GL AUTOMATION

expands the goni usability

The world of LED light measurement expands beyond traditional optical testing with thermal conditions, current or power levels also requiring measurement and reporting.

GL Spectrosoft Automation is an optional Add-on for Spectrosoft and it was purpose built to control these complex testing procedures. Once you connect all devices which are supported by the AUTOMATION software, building a custom measurement script is simply a matter of using the drag and drop interface and selecting the logical sequence from the list of available commands to the Automation editor window. Thanks to AUTOMATION the integration of programmable power supplies, power meters, temperature meters and even TEC controllers for thermal stabilization with the goni systems has become easier than never before.

TEC control

When working with LED modules or COBs you may need to stabilize the junction temperature. This is required for specific performance tests to verify flux output and intensity distribution under different temperatures. This option is also used for optical components testing used in lamp production like lenses, diffusers and reflectors.



Quality & Price

GL Optic uses only top quality sensors from a recognized Japanese supplier **HAMAMATSU** Photonics. Coating and diffusing materials together with profiles and housing parts come from trusted German suppliers. Our electronic boards and software interface are designed, manufactured and programmed in Poland.

Our own Calibration Standards are based on Russian VNIIFIL Institute of Physical Measurements which is the world's leading provider of Black Body reference standards used by NIST, NPL, PTB, and other top National Metrology Institutes.

The production facility and calibration laboratory of GL Optic is located in Western Poland, in the region of Poznan, which abounds in well-educated and trained human capital.



We are an European manufacturer with best price/quality ratio.

Support

Our roots are in the lighting industry and we understand light measurement from the lighting manufacturers' perspective.

GL Optic does not simply manufacture high quality instruments but it offers an extensive know-how support for its end-users to help them manage their complex measurement challenges.

We have a world wide experience in simplifying professional light measurements to improve the quality of light products.

GL Optic provides consultations, modifies or customizes solutions and supports customers in developing their light related business.

Online and onsite support, training and consultations are available.

Better than competition

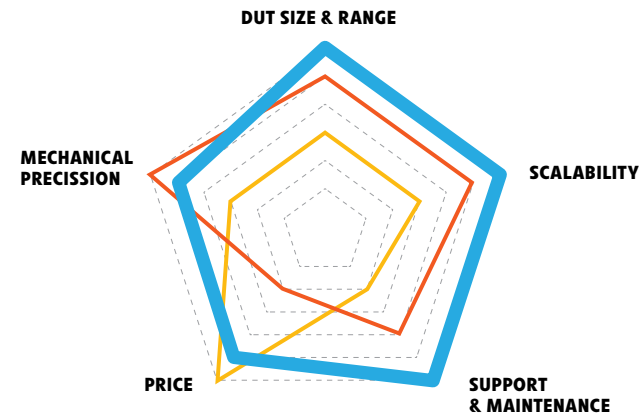

COMPETITIVE ANALYSIS TABLE

METROLOGY	
SPECTRORADIOMETER	Sony detector
Traceable calibration	n/a
PHOTOMETER	n/a
λ (lambda) filter spectral matching class	n/a
Stray light hood / tube	n/a
Photometric center alignment	
Distance measurement	Manually for C axis
Power measurement at DUT	OK
On-Fly measurements	n/a
n/a	n/a
OPERATION AND HANDLING	
Lamp mount	Light weight mounting rack
Cable connection to DUT	n/a
Electrical connectors at DUT	n/a
Adjustement of Z axis	Manual in fixed positions only
Integration of laboratory peripheral devices	n/a
TECHNICAL DATA	
CIE Goniometer Type	Far-field C gamma
Drivers	2 stepper motors
Angular range C axis	-
Angular range γ axis	-
Angular positioning precision	5° / 0.1°
Reproducibility C axis	-
Angular speed C axis	-
Angular speed γ axis	-
DUT photometric center positioning (Z axis distance)	Manually set positions only
PHOTOMETRIC DISTANCE	
DUT mounting plate (bread board)	n/a
Maximum DUT dimensions	1500 mm
Maximum load	25 kg
Size W/H/D	190 x 190 x 162,5 cm
Goniometer weight	79 kg
Power consumption	

LOW END SYSTEM	GL GONIO SYSTEM	HIGH END instrument
	Incl. SPECTIS 1.3 LS (Hamamatsu CMOS)	Optional (Hamamatsu CCD)
	Included NIST / PTB traceable	Optional NIST / PTB traceable
	Optional	Optional
	Class A	Class L
	Included / Optional	Included
	By controller for C; Gamma and Z	Controller for C and Gamma
	OK	OK
	OK	OK
	OK	n/a
	Industrial meachanical mounting plate	Industrial meachanical mounting plate
	Banana sockets	OK
	Internal cable connection from base to DUT with rotating connectors 4 banana sockets	Internal cable connection from base to DUT with rotating connectors 6 banana sockets
	Automatic smooth adjustement <770mm	Manual smooth adjustement <500mm
	Optional	Optional
	Far-field C gamma	Far-field C gamma
	3 stepper motors with absolute encoders*	3 Synchronous servo motors with angular encoders
	± 180°	-90° to +270°, protection with end switches
	± 180°	±165°, protection with end switches
	0.1° / encoder 0.004°	encoder 0.01°
	0.004°	≤0.1° (at rated load) ; ≤0.2° (under max. load)
	up to 45°/s	3.1°/s to 50°/s selectable (16 speeds)
	up to 45°/s	1.8°/s to 30°/s selectable (16 speeds)
	up to 770 mm, motor operated	to 500 mm via hand crank
	Round d=180 mm Fixing: multiple mounting holes: M3, M4, M5, M6; chuck with sliding blocks	210 mm x 210 mm with 3 x 3 grooves size 6; also various inserts with tapped threads
	1800 mm	2000 mm
	30 kg	50 kg
	750 x 1650 x 1950 mm	1852.5 x 1492 x 1798 mm;
	90 kg	660kg
	PC connection by USB A-B 110-230V 600W	230 V AC / 50 Hz; max. 1000 VA

* **What are Absolute Encoders?** Encoders can be either absolute or incremental. Absolute encoders have a unique code for each shaft position. Or in other words, every position of an absolute encoder is distinctive. The absolute encoder provides precise information on an absolute position of the goniometer system not just by counting number of steps like stepper motors do but by a unique coding signal for each position. Oct 6, 2011 Source: <https://www.motioncontroltips.com/absolute-encoders/>

technical data

GL GONIOMETER



**Large
GLG30-1800**



**Table top
GLG 4-500 Light Goniometer**

APPLICATION

Large LED modules and large luminaires.
Compliance with the following: CIE121-1996,
IESNA LM-79-08, CIE S 025/E:2015

Large LED modules and large luminaires.
Compliance with the following: CIE121-1996,
IESNA LM-79-08, CIE S 025/E:2015

TECHNICAL DATA SHEET

CIE Goniometer type	Far Field Type C with horizontal optical axis	Far Field Type C with horizontal optical axis
	<ul style="list-style-type: none"> DUT moving 3 axis stepper motors with worm drive gear boxes Total position encoders directly on axis 	<ul style="list-style-type: none"> DUT moving 2 axis stepper Belt drive system
Angular range C axis	± 180°	± 180°
Angular range γ axis	± 180° theoretical (usable depending on geometry due to shadowing)	± 180° theoretical (usable depending on geometry due to shadowing)
Angular positioning precision	0.1°	0.1°
Reproducibility C axis	0.004°	0.1°
Reproducibility γ axis	0.004°	0.1°
Angular speed C axis	up to 45°/s	up to 45°/s
Angular speed γ axis	up to 45°/s	up to 45°/s
DUT photometric center positioning	700 mm; stepper motor operated	0 to 180 mm; via hand crank
Photometric distance	9 – 27 m Distance ≥ largest DUT dimension x(5 to 15); (CIE S 025/E:2015)	2.5 – 7.5 m Distance ≥ largest DUT dimension x (5-15); (CIE S 025/E:2015)
DUT mounting plate (bread board)	Round d=180 mm Fixing: multiple mounting holes: M3, M4, M5, M6; chuck with sliding blocks	Square 80 x 80 mm Fixing: multiple M6 mounting holes
Maximum DUT dimensions	≤ 1800 mm (diameter or diagonal)	≤ 500 mm (diameter or diagonal)
Goniometer dimensions	750 x 1650 x 1950 mm (W x H x D)	300 x 470 x 530 mm (W x H x D)
Maximum operating footprint diameter	2400 mm	1100 mm (when vertical axis is fully extended)
Maximum load	30 kg	4 kg
Goniometer weight	80 kg	8 kg
Power supply and max. consumption	PC connection by USB A-B 110–230V 600W	PC connection by USB A-B 110–230 V 40W
Sensor type	GL OPTIC Spectrometer range: <ul style="list-style-type: none"> GL Spectis 1.3 LS (recommended) GL Spectis 1.0 Touch LS GL Spectis 1.0 Touch + Flicker GL Spectis 5.0 Touch GL Photometer 3.0 LS + FLICKER 	GL OPTIC Spectrometer range: <ul style="list-style-type: none"> GL Spectis 1.3 LS (recommended) GL Spectis 1.0 Touch LS GL Spectis 1.0 Touch + Flicker GL Spectis 5.0 Touch GL Photometer 3.0 LS + FLICKER
Product no.	201736	202046

GL SPECTROMETER



GL SPECTIS 1.3 LS



GL SPECTIS 5.0 Touch VIS



GL PHOTOMETER 3.0 LS + FLICKER

TECHNICAL DATA SHEET

	GL SPECTIS 1.3 LS	GL SPECTIS 5.0 Touch VIS
Spectral range	340-750 nm	200-1050 nm
Detector	CMOS image sensor	CCD Backed thinned image sensor
Number of pixels	256	2048
Physical resolution	~ 1.7 nm / ~ 1.8 nm	~ 0.5 nm
Optical FWHM	~ 10 nm	2.5 nm
Measurement range	1 – 200.000 lx [Illuminant A]	1 – 200.000 lx [Illuminant A]
Wavelength reproducibility	0.5 nm	0.5 nm
Integration time	5 ms to 60 s	5 ms to 60 s
A/D conversion	16 bits	16 bits
Signal to noise ratio	1000:1	1000:1
Cosine correction	Class B – DIN 5032-7 Class AA – JIS C 1609-1:2006	Class B Class A Optional DIN 5032 Part 7
Stray light	2*10 E-3	3*10 E-4
Spectroradiometric accuracy	5 % within range 340 – 500 nm 4 % within range 500 – 780 nm	4%
Measurement uncertainty of colour coordinates (x,y)	0.0015	0.0015
PC interface	–	USB 2.0 standard
Display full colour	–	240 x 320 px
WiFi	–	802.11b/g
Micro SD card	–	4GB
Power	Power USB	lithium-ion battery 4000mAh
Power consumption	< 640 mA	~ 700 mA
Power supply	–	Input: AC 100-240V 50/60Hz 0.15A Output: 5V-1A
Ambient temperature	5-35°C	5-35°C
Dimensions	72 mm x 115 mm x 19 mm	111 mm x 210 mm x 58 mm
Weight	120 g	1500 g
Product no.	106989	

APPLICATION

High quality flicker measurements including long term sampling, fast goniometric measurements, high precision illuminance measurements

TECHNICAL DATA SHEET

Measurement range	0,0001 lx ... 5 000 000 lx*
Resolution	0,0001 lx
Uncertainty of spectral response (f1)	Class A < 3 %
Sampling frequency	100 kHz
A/D conversion	18 bit
Software	GL Spectrosoft or API for external software developers
Dimensions [H x W x D]	115 mm x 66 mm x 51 mm
Weight	350g
Connectivity	USB A-B
Power	USB , 5V <200mA
Tripod adapter	1/4"
Product no.	202294

* standard measuring range can be extended by customization



Light quality control



- - Office
- - Resellers
- - Clients

Contact us:

GERMANY

GL OPTIC LICHTMESSTECHNIK GMBH
Tobelwasenweg 24
73235 Weilheim / Teck
Germany

Phone: +49 7023 9504 0
Fax: +49 7023 9504 837
E-mail: office@gloptic.com

FRANCE

JUST NORMLICHT FRANCE SÀRL
3, Rue Louis Pasteur
67240 Bischwiller
France

Phone: +33 (0) 3 8806 2822
Fax: +33 (0) 3 8806 2823
E-mail: info@just-normlicht.fr

USA

JUST NORMLICHT INC.
2000 Cabot Blvd. West Suite 120
Langhorne, PA 19047-2408
United States

Phone: +1 267 852-2200
Fax: +1 267 852-2207
E-mail: sales@justnormlicht.com

POLAND

GL OPTIC Polska Sp. z o.o. Sp.k
ul. Poznańska 70
62-040 Puszczykowo
Poland

Phone: +48 61 819 40 03
E-mail: office@gloptic.com